



Compact and stylish desk-top unit providing flexible modular power and data distribution; ideal for office desks and screens. PULSE 'floats' above the desk releasing the desktop and takes its design influence from modern life – clean, simple lines with no-nonsense understated function and uncompromising style.

PULSE can be manufactured to meet specific requirements with mains power sockets formats for most countries together with a wide range of data outlets.

PULSE continues **OE** Electrics 'soft' theme with interchangeable fixings to suit any desk location, including screens. Please specify when requesting a quote

Standard colours are grey and white or black and white (certain countries will be black and white)

All **OE** Electrics products are manufactured to enable compliance with BS6396 or BS7671 where relevant.



USPs

- 'Floats' above the desk releasing the desktop
- Available with TUF charger
- BS6396 compliant (where applicable)
- Available with sockets from different nationalities
- Numerous fitting options



technical

Common Modular Components*

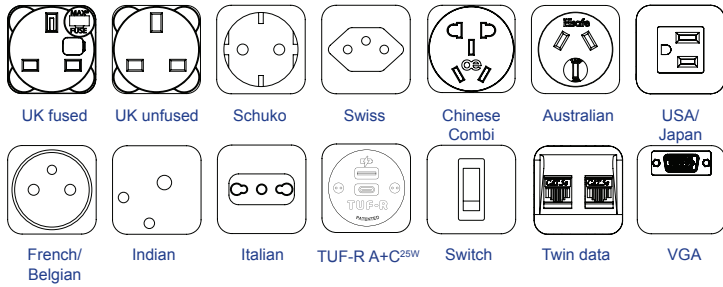

*See website for more

Unit dimensions

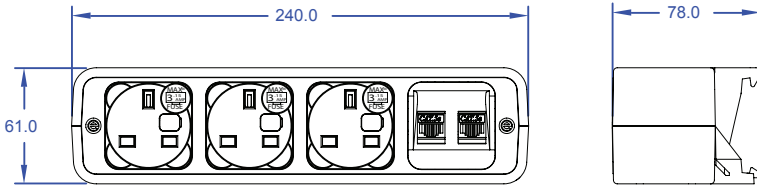

Common Units

Other configurations are available on request

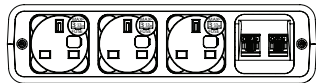

Pulse 1001

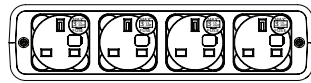

Pulse 1002

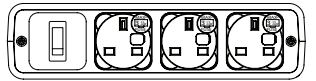

Pulse 1005

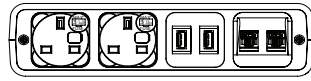

Pulse 1007

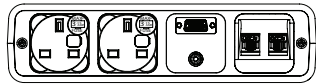

Pulse 1008

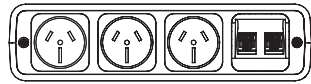

Pulse 1009

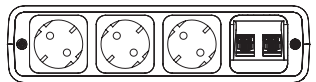

Pulse 1010

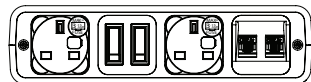

Pulse 1011

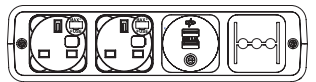

Pulse 1132

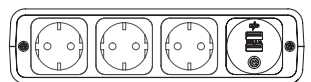

Pulse 1147

Standard Fixings

- PCB Clamp Bracket 15 - 35mm
- PEC Clamp Bracket (Extended) 38 - 55mm⁺
- PLC Clamp Bracket (Long-Reach) 15 - 35mm⁺
- PTR Tool rail fixing*
- HTC HT Beam fixing

*Please call to confirm screen/toolrail compatibility

+Available on application

Features

Configuration:

Power only / Data only / Combined (Power & Data/AV)
Internal segregation between Power and Data/AV in combined PULSE

Insulation:

Re-inforced insulation

Earth Bonding:

A 250mm earth lead can be included to allow earth bonding to furniture.

Fusing: (to enable compliance to BS6396)

5 x 20mm anti-surge ceramic fuses, with colour-coded fuseclips to denote the rating (3.15A/5A)

Testing:

100% testing - continuity, polarity, insulation & earth

Soft Wiring (power)

Power wired to Wieland GST connector allows starter cables to be changed to suit requirements, especially useful during moves and changes (CHURN)

Angled cable grip means the cable can exit via the rear or the bottom without the need for tools, allowing flexibility for mounting PULSE

Soft Wiring (data)

As well as soft-wired power, PULSE can accommodate soft wired data. Using our inline couplers, data cables can be changed "on-site" to accommodate changes in length often associated with churn.

PTR - Screen Fixing

Standard tool-rail bracket
Please call for confirmation

HTC - HT Beam

fixing - suitable for
fixing to HT Beam

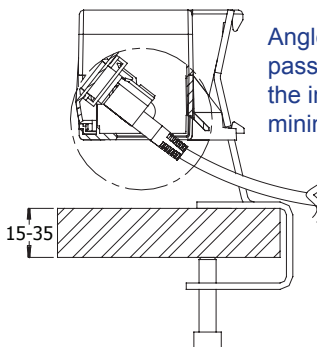
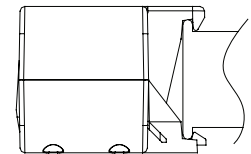
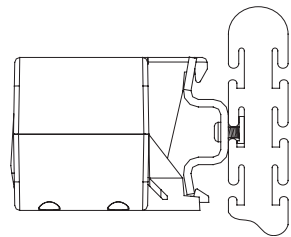

Angled data fascias allow data cabling to pass straight through PULSE, ensuring the integrity of cables which have a minimum bend radii (CAT5e, CAT6 etc)

CB - Clamp Bracket

Clamps are available for desk thicknesses between 15 and 35mm
(Call for other desk thicknesses)